



# COOKING EQUIPMENT

SERVING THE FOOD INDUSTRY SINCE 1951

## PYRALIS PIZZA OVENS WITH DOUBLE CHAMBER AND DIGITAL DISPLAY

Item: 40643

Model: PE-IT-0049-DD

**WITH  
ACTIVESTONE  
TECHNOLOGY**

Pyralis ovens have a steel front, pre-painted white grey body, steel door with glass, a knob for opening and closing the steam exhauster and non-thermal handles.



### The Activestone

Therographic test show that in a chamber heated by Activestone, the desired temperature can be reached within a shorter time span and heat is distributed evenly.

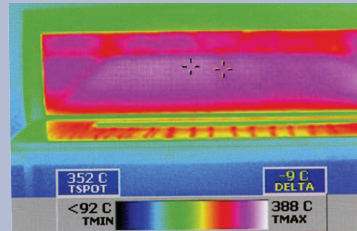
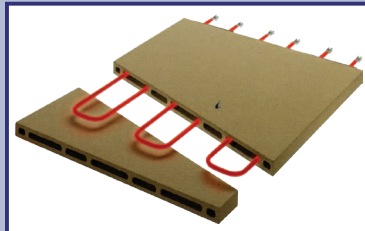

ACTIVESTONE



**WARRANTY**  
PARTS AND LABOR



LOCALLY  
**QPS**  
APPROVED



Authorized Dealer

# COOKING EQUIPMENT

PYRALIS PIZZA OVEN WITH DOUBLE CHAMBER AND DIGITAL DISPLAY



Digital display

## Features:

The Pyralis is an electric oven that was designed and built to offer extremely high levels of performance, efficiency and reliability with low operating costs. The digital version has an electronic card that is used to program the start to end of baking and two work settings (continuous/P2 and non-continuous/P1). The digital Pyralis has a safety thermostat and independent chambers. Upon request, some models can be produced with single-phase voltage.

\* *Special Order are available for the following upon request: stainless stands, casters, hoods, vents and suction motor.*





## 18 kW Pyralis Series Oven with Double Chamber and Digital Display featuring Active Stone

ITEM NUMBER	40643
MODEL	PE-IT-0049-DD
TEMPERATURE	842° F / 450° C
ELECTRICAL	220V / 60 / 3
POWER	18 kW
CHAMBER DIMENSIONS (LxDxH)	41.3" x 27.6" x 5.9" (x2)/ 1050 x 700 x 150 (x2)
EXTERNAL DIMENSIONS (LxDxH)	56.7" x 39.8" x 29.5" / 1440 x 1010 x 750 mm
PACKAGING DIMENSIONS (LxDxH)	44" x 57.7" x 33" / 1120 x 1470 x 840 mm
WEIGHT	Net Weight: 231 kg / 508.2 lbs. Gross Weight: 254 kg / 558.8 lbs.

## Related Accessories - sold separately

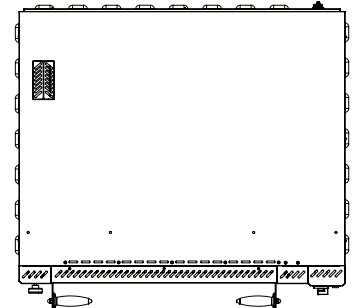
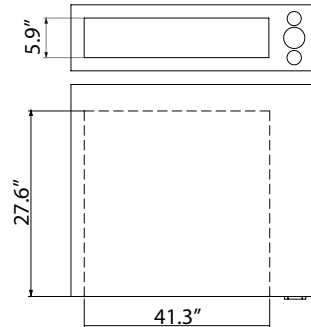
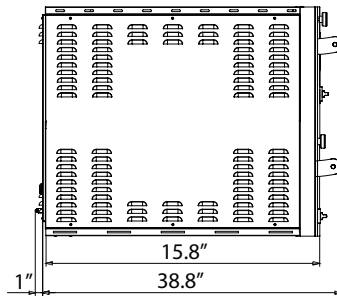
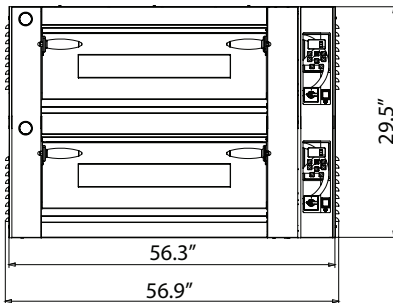
ITEM NUMBER	DESCRIPTION
40642	Stainless steel stand
40644	Stainless steel hood
40645	Wheels for all pizza oven stands

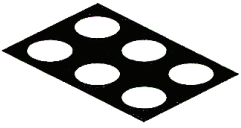
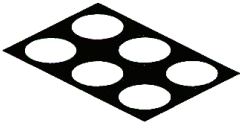

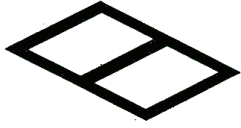
 max 6 x 12"	 max 6 x 13"	 max 2 x 18"	 max 2 x (24" x 16")
--	--	---	--

## OMCAN INC.

Telephone: 1-800-465-0234  
 Fax: (905) 607-0234  
 E-mail: sales@omcan.com  
 Website: www.omcan.com



Follow us to keep up to date with the latest news and offers

