

PATIO HEATER

INSTRUCTION MANUAL



Keep the instructions for future reference



WARNING SAFETY RULES

PLEASE READ THE FOLLOWING SAFETY RULES PRIOR TO OPERATION OF THE HEATER

FOR YOUR SAFETY

If you smell gas:

1. Shut off gas to the appliance.
2. Extinguish any open flame.
3. If odor continues, immediately call your gas supplier or your fire Department.

FOR YOUR SAFETY

1. Do not store or use gasoline or other flammable vapors and liquids in the vicinity of this or any other appliance.
2. An LP cylinder not connected for use shall not be stored in the vicinity of this or any other appliance.

WARNING

- 1) For use outdoors or in amply ventilated areas.
- 2) An amply ventilated area must have a minimum of 25 % of the surface area open.
- 3) The surface area is the sum of the walls surface.

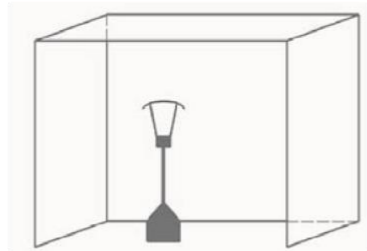

WARNING: Improper installation, adjustment, alteration, service or maintenance Can cause injury or property damage. Read the installation, operating and maintenance instructions thoroughly before installing or servicing this equipment.

STEP 7

- 7-1. Bring up the tank housing and rest it on the post plate.
- 7-2. Connect the end thread of inlet gas hose to the regulator.
- 7-3. Connect the regulator to the gas tank and tighten it with adjustable wrench.
- 7-4. Put LPG gas tank on the stand.

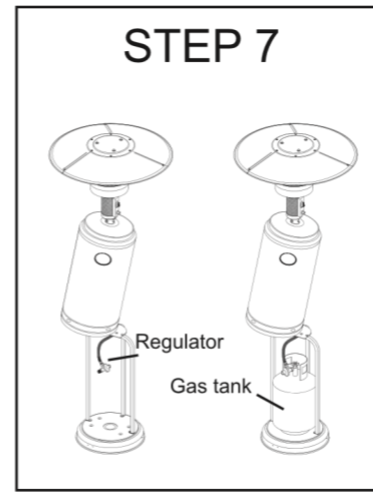

PROBLEMS CHECK LIST

<u>PROBLEM</u>	<u>PROBABLE CAUSE</u>	<u>SOLUTION</u>
Pilot will not light	Gas valve may be OFF	Turn the gas valve ON
	Tank fuel empty	Refill LPG tank
	Opening blocked	Clean or replace opening
	Air in supply system	Purge air from lines
	Loose connections	Check all fittings
Pilot will not stay on	Debris around pilot	Clean dirty area
	Loose connections	Tighten connections
	Thermocouple bad	Replace thermocouple
	Gas leak in line	Check connections
	Lack of fuel pressure	Tank near empty. Refill LPG tank.
Burner will not light	Pressure is low	Tank near empty. Refill LPG tank.
	Opening blocked	Remove and clean
	Control not ON	Turn valve to ON
	Thermocouple bad	Replace thermocouple
	Pilot light assembly bent	Place pilot properly
	Not in correct location	Position properly and retry

If the appliance is in case of any defaults or problems of assembly or use, please don't try to modify it by yourself, contact your supplier or distributor to solve it.

warning

Read the instructions before installation and use.

- This appliance must be installed and the gas cylinder stored in accordance with the regulations in force;
- Do not obstruct the ventilation holes of the cylinder housing;
- Do not move the appliance when in operation;
- Shut off the valve at the gas cylinder or the regulator before moving the appliance;
- The tubing or the flexible hose must be changed within the prescribed intervals;
- Use only the type of gas and the type of cylinder specified by the manufacturer;

The LP tank used with your patio heater must meet the following requirements:

Purchase LP tanks only with these required measurements:
(31.8cm) (diameter) x 58cm (tall) with 15kg capacity maximum.

-In case of violent wind particular attention must be taken against tilting of the appliance; Keep the appliance at least 1m from the gas cylinder.

-The injector is installed by the manufacturer only.

Do not connect the gas cylinder directly to the appliance without regulator. Use only the type of gas and the type of cylinder specified in the instructions.

A regulator (complies with EN16129:2013 and the national regulation) of the correct pressure corresponding to the appliance category.
Use 30mbar regulator for butane/propane under the category I3B/P(30).
Use 30mbar regulator for butane under the category I3+(28-30/37).
Use 37mbar regulator for propane under the category I3+(28-30/37).
Use 50mbar regulator for butane/propane under the category I3B/P(50).
It's recommended to use flexible hose that approved by EN16436: 2014.

TABLE OF CONTENTS

Caution	1
Heater Stand and Location	2
Gas Requirements	2
Leakage Test	2
Operation and Storage	3
Cleaning and Care	4
Parts and Specifications	4
Assembly Parts and Procedures	6
Problems Check List	9

STEP 4

- 4-1. Remove the 4 bolts from the burner.
- 4-2. Put the gas hose through into the post.
- 4-3. Fix the burner unit to the post by the 4 bolts.

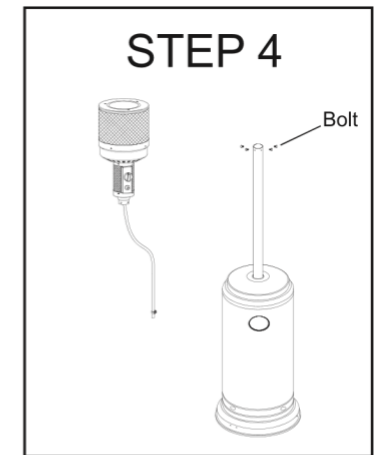

STEP 5

- 5-1. Check whether the connection of vertical post and burner are assembled according to instructions, and all bolts and nuts are tightened.
- 5-2. Put 6 pcs Large Flat Washers on 3 Reflector Spacers.

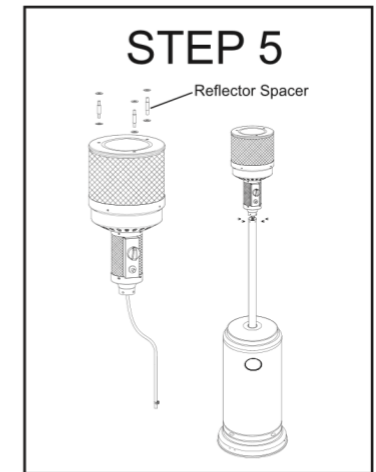

STEP 6

- Fasten the reflector with 3 pcs Large Flat Washers and 3 pcs Wing Nuts.

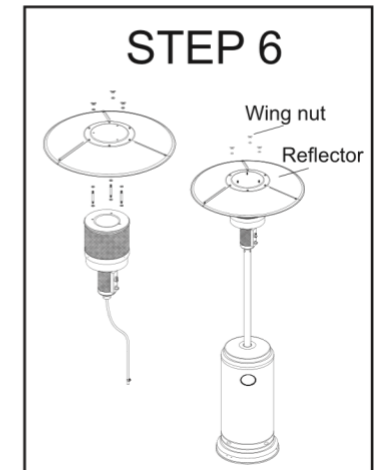

ASSEMBLY PROCEDURES

STEP 1

- 1-1. Put the 3 pcs post brackets on each position on the base as shown in the picture.
- 1-2. Use 3 Medium Bolts(M8x16) to join the post brackets and stand.

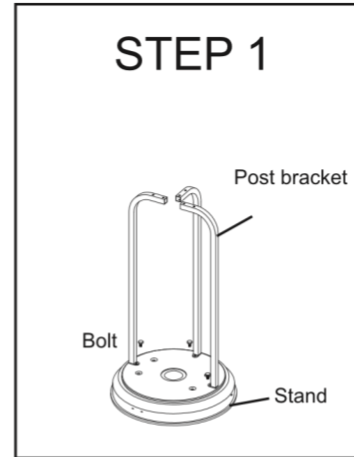

STEP 2

- 2-1. Put the post on the top of 3 pcs post brackets.
- 2-2. Use 6 Large Bolts and Flange Nuts (M6) to connect the post to the 3 pcs post brackets. Tighten the bolts and nuts.

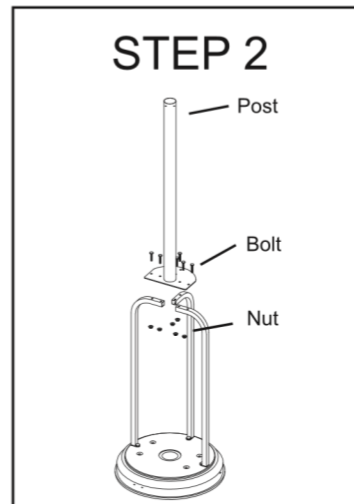

STEP 3

- Place the tank housing on the stand.

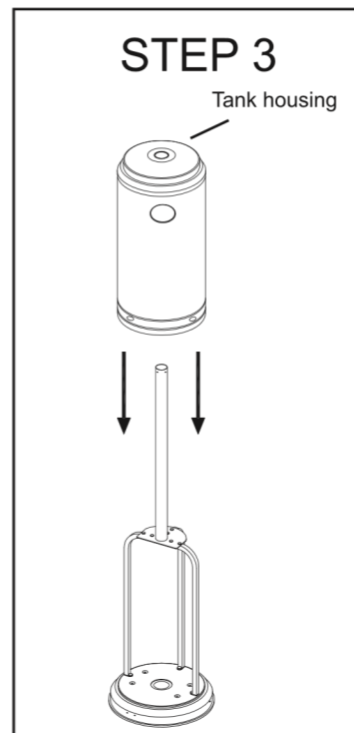

CAUTION

PLEASE READ CAREFULLY THE FOLLOWING SAFETY GUIDELINES BEFORE OPERATION.

- Do not use the patio heater for indoors, as it may cause personal injury or property damage.
- This outdoor heater is not intended to be installed on recreational vehicles and/or boats.
- Installation and repair should be done by a qualified service person.
- Improper installation, adjustment, alteration can cause personal injury or property damage.
- Do not attempt to alter the unit in any manner.
- Never replace or substitute the regulator with any regulator other than the factory-suggested replacement.
- Do not store or use gasoline or other flammable vapors or liquids in the heater unit.
- The whole gas system, hose, regulator, pilot or burner should be inspected for leaks or damage before use, and at least annually by a qualified service person.
- All leak tests should be done with a soap solution. Never use an open flame to check for leaks.
- Do not use the heater until all connections have been leak tested.
- Turn off the gas valve immediately if smell of gas is detected. Turn Cylinder Valve OFF. If leak is at Hose/Regulator connection: tighten connection and perform another leak test. If bubbles continue appearing should be returned to hose's place of purchase. If leak is at Regulator/Cylinder Valve connection: disconnect, reconnect, and perform another leak check. If you continue to see bubbles after several attempts, cylinder valve is defective and should be returned to cylinder's place of purchase.
- Do not transport heater while it's operating.
- Do not move the heater after it has been turned off until the temperature has cooled down.
- Keep the ventilation opening of the cylinder enclosure free and clear of debris.
- Do not paint the radiant screen, control panel or top canopy reflector.
- Control compartment, burner and circulation air passageways of the heater must be kept clean. Frequent cleaning may be required as necessary.
- The LP tank should be turned off when the heater is not in use.
- Check the heater immediately if any of the following occurs:
 - The heater does not reach temperature.
 - The burner makes popping noise during use (a slight noise is normal when the burner is extinguished).
 - Smell of gas in conjunction with extreme yellow tipping of the burner flames.
- The LP regulator/hose assembly must be located out of pathways where people may trip over it or in area where the hose will not be subject to accidental damage.
- Any guard or other protective device removed for servicing the heater must be replaced before operating the heater.
- Adults and children should stay away from high temperature surface to avoid burns or clothing ignition.
- Children should be carefully supervised when they are in the area of the heater.
- Clothing or other flammable materials should not be hung on the heater or placed on or near the heater.
- To change the gas cylinder in a amply ventilated area, away from any ignition source (candle, cigarettes, other flame producing appliances, ...);
- To check that the regulator seal is correctly fitted and able to fulfill its function showed as photo right;
- To not obstruct the ventilation holes of the cylinder housing;
- To close the gas supply at the valve of the gas cylinder or the regulator after use;
- In the event of gas leakage, the appliance shall not be used or if a light, the gas supply shall be shut off and the appliance shall be investigated and rectified before it is used again;
- To check the hose at least once per month, each time the cylinder is changed, or each time before long time no use. If it shows signs of cracking, splitting or other deterioration it shall be exchanged for new hose of the same length and of the equivalent quality;
- The use of this appliance in enclosed areas can be dangerous and is PROHIBITED;
- Read the instructions before using this appliance. The appliance must be installed in accordance with the instructions and local regulations.
- For connection of hose and regulator, and connection of regulator and hose, please refer to photo showed above.

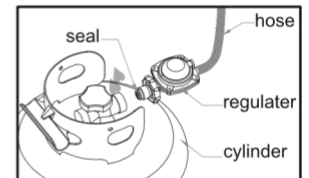

Hose/ Regulator connection and Regulator / Cylinder connection

ASSEMBLY PARTS

HEATER STAND AND LOCATION

- The heater is primarily for outdoor use only. Always ensure that adequate fresh air ventilation is provided.
- Always maintain proper clearance to combustible materials, i.e. top 100 cm and sides 100 cm minimum.
- Heater must be placed on level firm ground.
- Never operate heater in an explosive atmosphere like in areas where gasoline or other flammable liquids or vapors are stored.
- To protect heater from strong wind, anchor the base securely to the ground with screws.

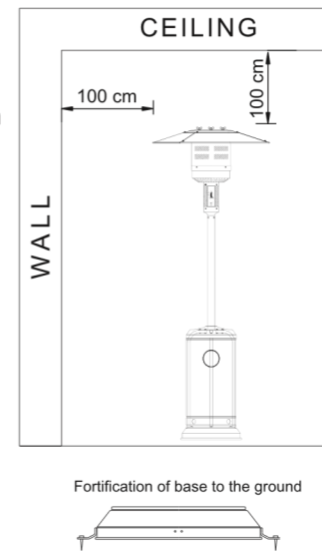

GAS REQUIREMENTS

- Use propane or butane gas only.
- The pressure regulator and hose assembly to be used must conform to local standard codes.
- The installation must conform to local codes, or in the absence of local codes, with the standard for the storage and handling of liquid petroleum gases.
- A dented, rusted or damaged propane tank may be hazardous and should be checked by your tank supplier. Never use a propane tank with a damaged valve connection.
- The propane tank must be arranged to provide for vapor withdrawal from the operating cylinder.
- Never connect an unregulated propane tank to the heater.

LEAKAGE TEST

Gas connections on the heater are leak tested at the factory prior to shipment. A complete gas tightness check must be performed at the installation site due to possible mishandling in shipment or excessive pressure being applied to the heater.

- Make a soap solution of one part liquid detergent and one part water. The soap solution can be applied with a spray bottle, brush or rag. Soap bubbles will appear in case of a leak.
- The heater must be checked with a full cylinder.
- Make sure the safety control valve is in the OFF position.
- Turn the gas supply ON.
- In case of a leak, turn off the gas supply. Tighten any leaking fittings, then turn the gas supply on and re-check.
- Never leak test while smoking.

ASSEMBLY PARTS

HARDWARE CONTENTS (shown actual size)

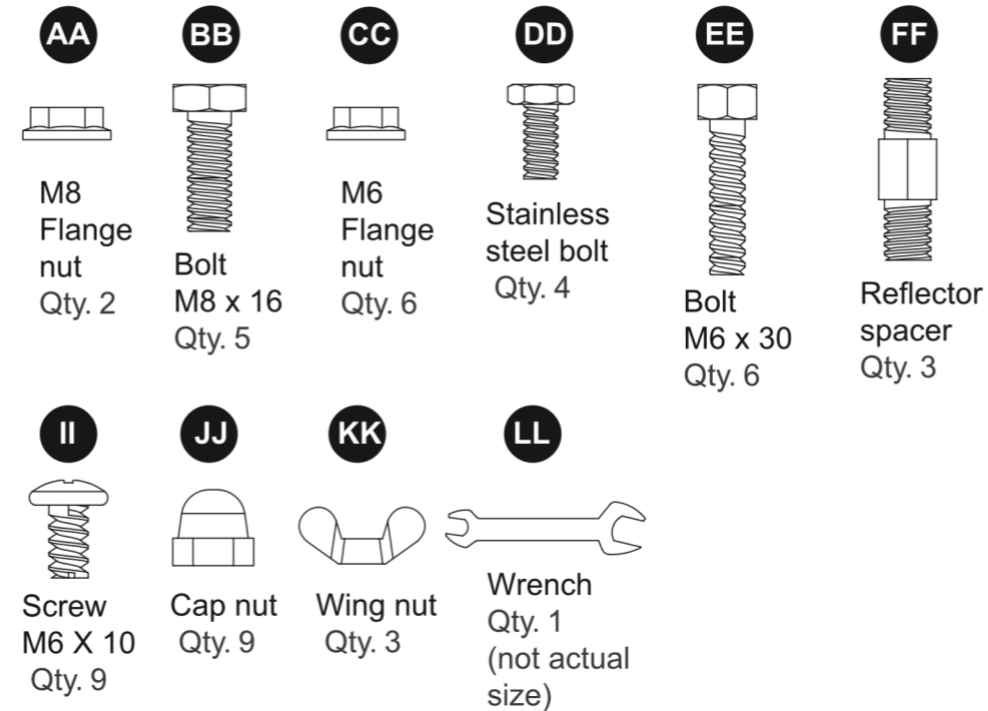

OPERATION AND STORAGE

Tools needed:

- Open end wrench 10 & 13 mm
- Adjustable opening wrench (2) 20 cm long
- Slip joint pliers 23 cm long
- Philips screwdriver w/ medium blade
- Spray bottle of soap solution for leakage test

Parts List:

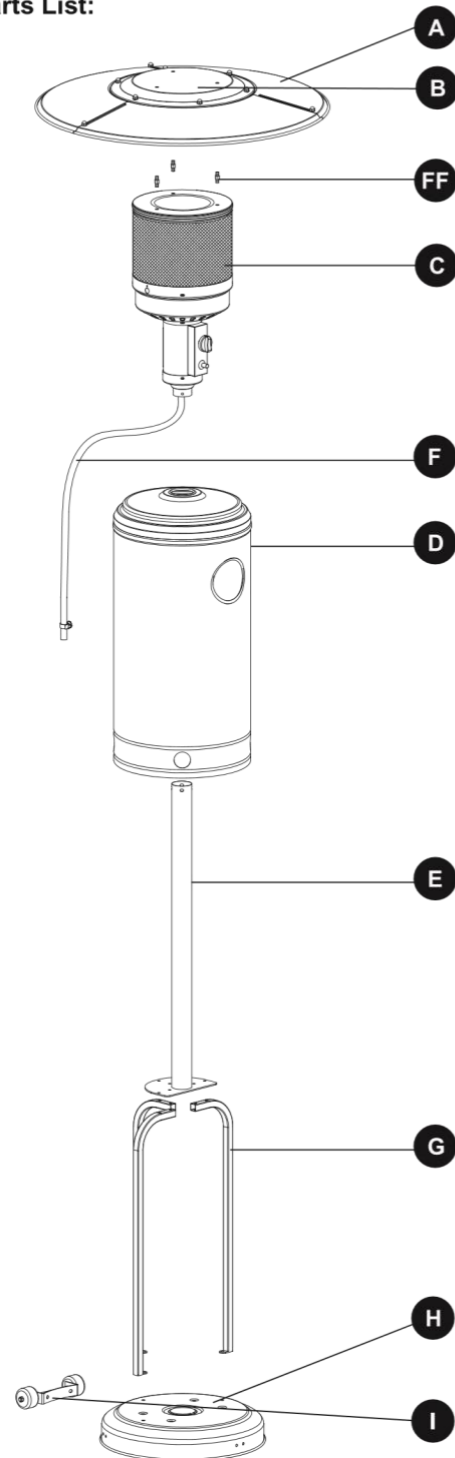

PART	DESCRIPTION	QUANTITY
A	Reflector Panel	3
B	Reflector Plate	1
FF	Reflector Stud	3
C	Head Assembly	1
D	Cylinder Housing	1
E	Post	1
F	Gas Hose	1
G	Support Bracket	3
H	Base	1
I	Wheel Kit	1

TO TURN ON THE HEATER

1. Turn on the valve on the gas supply cylinder completely.
2. Press and turn the variable control knob to PILOT position (counter-clockwise 90°).
3. Press down the variable control knob and hold for 60 seconds. While holding down the variable control knob, press the igniter button several times until the pilot flame lights. Release the variable control knob after the pilot flame lights.

Note:

- If a new tank has just been connected, please allow at least one minute for the air in the gas pipeline to purge out through the pilot hole.
 - When lighting the pilot flame make sure that the variable control knob is continuously pressed down while pressing the igniter button. Variable control knob can be released after the pilot flame lights.
 - Pilot flame can be watched and checked from the small round window with sliding lid located at the bottom of the flame screen (to the left or right side of the controller).
 - If the pilot flame does not light or it goes out, repeat step 3.
4. After the pilot flame lights, turn the variable control knob to maximum position and leave it there for 5 minutes or more before turning the knob to desired temperature position.

TO TURN OFF THE HEATER

1. Turn the variable control knob to PILOT position.
2. Press and turn the variable control knob to OFF position.

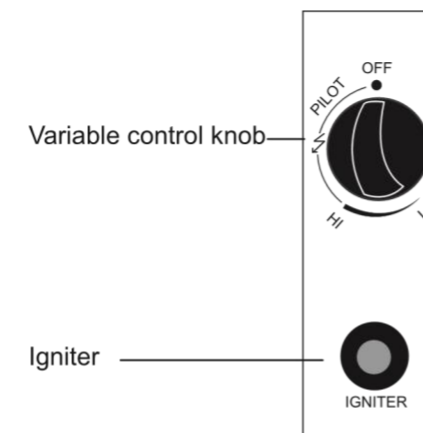

OFF: the heater stop work
 HI: maximum temperature position
 LO: minimum temperature position

3. Turn off the valve on the gas supply cylinder completely.

Storage

1. Always close the gas valve of the gas cylinder after use or in case of a disturbance.
2. Remove the pressure controller and the hose.
3. Check the tightness of the gas valve and for damage. If you suspect a damage, have it changed by your gas dealer.
4. Never store liquid gas cylinder in a sub-terrain, or at places without adequate air ventilation.

CLEANING AND CARE

- Wipe off powder coated surfaces with soft, moist rag. Do not clean heater with cleaners that are combustible or corrosive.
- Remove debris from the burner to keep it clean and safe for use.
- Cover the burner unit with the optional protective cover when the heater is not in use.

PARTS AND SPECIFICATIONS

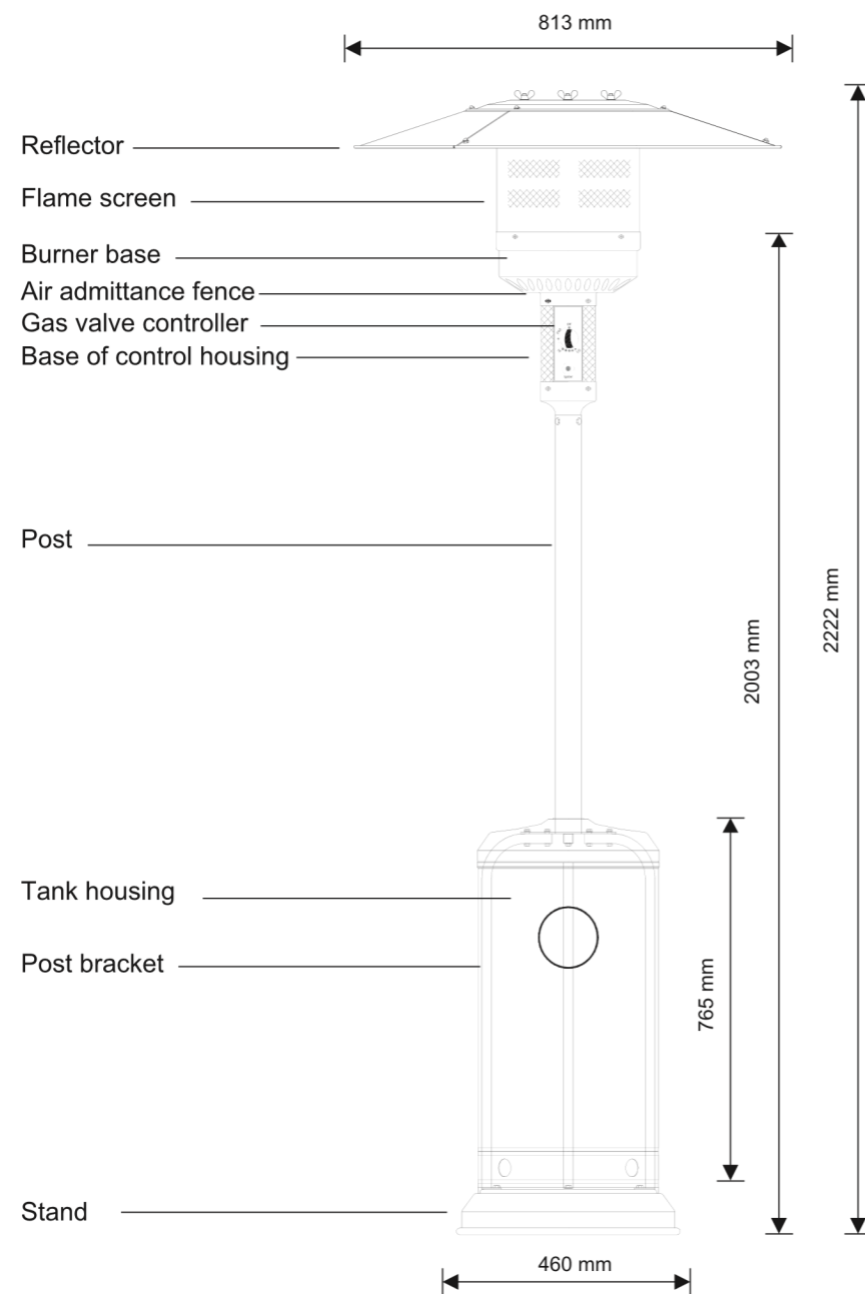

A. Construction and characteristics

- Transportable terrace/garden heater with tank housing
- Casing in steel with powder-coating or stainless steel
- Gas hose connections with metal clamp (screw caps for Germany)
- Heat emission from reflector

B. Specifications

- Use propane, butane or their mixtures gas only.
- Max. wattage: 13000 watts
- Min. wattage: 5000 watts
- Consumption:

APPLIANCE CATEGORY:	I ₃₊ (28-30/37)		I _{3B/P} (30)	I _{3B/P} (50)	I _{3B/P} (37)
TYPES OF GAS:	Butane	Propane	Butane, propane or their mixtures	Butane, propane or their mixtures	Butane, propane or their mixtures
GAS PRESSURE:	28-30mbar	37 mbar	30 mbar	50mbar	37mbar
OUTLET PRESSURE OF REGULATOR:	30mbar	37 mbar	30 mbar	50mbar	37mbar

- Using the proper regulator according to outlet pressure of regulator as showed in the table above.

C. Table of injector

APPLIANCE CATEGORY:	I ₃₊ (28-30/37)		I _{3B/P} (30)	I _{3B/P} (50)	I _{3B/P} (37)
TYPES OF GAS:	Butane	Propane	Butane, propane or their mixtures	Butane, propane or their mixtures	Butane, propane or their mixtures
GAS PRESSURE:	28-30mbar	37 mbar	30 mbar	50mbar	37mbar
TOTAL HEAT INPUT (Hs): (Qn)	13kW (G30:945g/h; G31:929g/h)				
INJECTOR SIZE:	1.90 mm for main burner 0.18 mm for pilot burner			1.70 mm for main burner 0.18 mm for pilot burner	1.80 mm for main burner 0.18 mm for pilot burner
The marking, for example, 1.90 on the injector, indicates that the size of injector is 1.90mm					

- The hose and regulator assembly must conform to local standard codes.
- Regulator outlet pressure should meet the corresponding gas category in the table of injector.
- The appliance requires approved hose in 1.4m length.