



MEAT SLICERS

VOLANO MANUAL SLICERS - 10" / 12" / 14" / 14.5" BLADES



Built for durability and consistent slicing

Ideal for prosciutto slicing

Fully hand-operated



Authorized Dealer



WARRANTY
PARTS AND LABOR



MEAT SLICERS

VOLANO MANUAL SLICERS

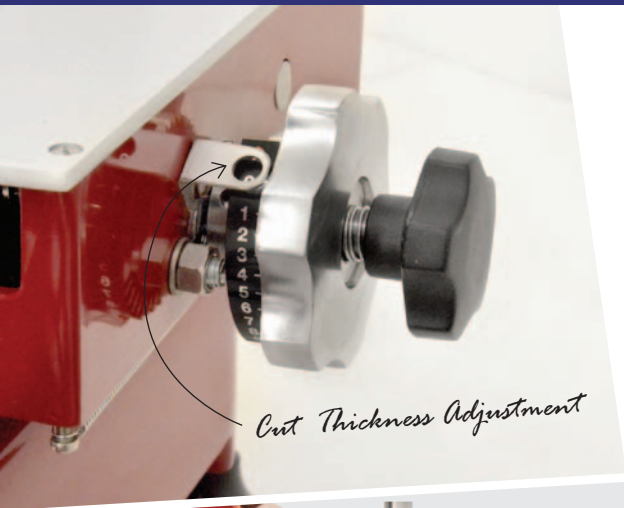

Cut Thickness Adjustment

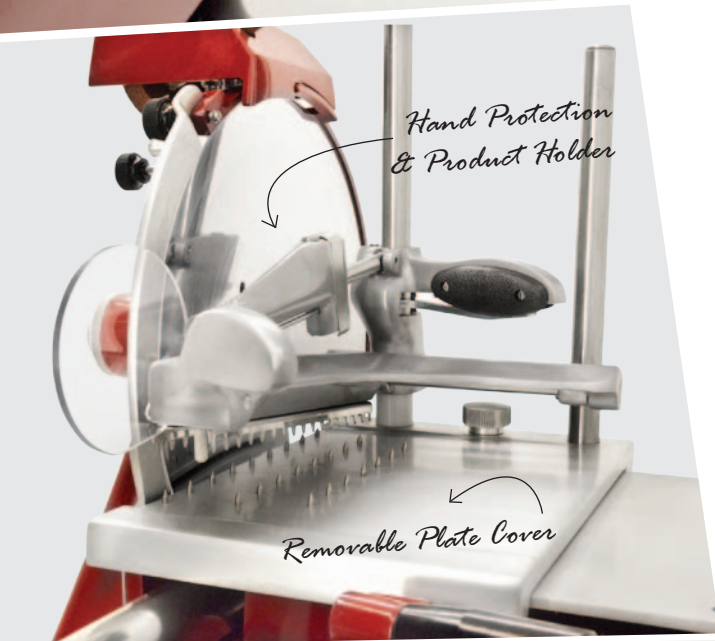

Hand Protection & Product Holder

Removable Plate Cover



Removable Sharpener With Protection Cover



**TRADITIONAL RED COLOR
Standard Flywheel**



**TRADITIONAL RED COLOR
Flower Flywheel**



Features:

- Fully hand-operated. Ideal for prosciutto slicing
- Variable cut thickness
- Made of aluminium with parts of steel and black finishing
- Equipped with blade guard for safe cleaning and operations
- Built-in blade sharpeners for effective and sharp cutting
- Designed for durability and consistent slicing

Optional Items:

- Cast-iron made pedestal
- Special colors and types of flywheel are available upon request



Standard Flywheel



Resette Flywheel



Daisy Flywheel

For more info, please call us 1-800-465-0234

OMCAN INC.

Telephone: 1-800-465-0234
 Fax: (905) 607-0234
 E-mail: sales@omcan.com
 Website: www.omcan.com



Follow us to keep up to date with the latest news and offers



MEAT SLICERS

VOLANO MANUAL SLICERS



Manual Volano Slicers With **Standard Flywheel** - 10"/12"/ 14"/ 14.5" Dia. Blades

- 10" Blade Size - Item 20013
- 12" Blade Size - Item 13634
- 14" Blade Size - Item 13639
- 14.5" Blade Size - Item 18830



ITEM	MODEL	BLADE SIZE	CUTTING SIZE	CUT THICKNESS	NET WEIGHT	GROSS WEIGHT	GROSS DIMENSIONS
20013	MS-IT-0250-M	10"/ 250 mm	7.3" x 5.9"/ 185.4 x 150 mm	0-2 mm	72.6 lbs./ 33 kg	124 lbs./ 56 kg	30" x 30" x 27"/ 762 x 762 x 686 mm
13634	MS-IT-0300-M	12"/ 300 mm	9" x 7.5"/ 228.6 x 190.5 mm	0-2 mm	100 lbs./ 45 kg	169 lbs./ 76.7 kg	30" x 30" x 27"/ 762 x 762 x 686 mm
13639	MS-IT-0350-M	14"/ 350 mm	10.62" x 9.44"/ 270 x 240 mm	0-2.5 mm	178 lbs./ 80.7 kg	198 lbs./ 90 kg	37" x 33" x 38"/ 940 x 838 x 965 mm
18830	MS-IT-0370-M	14.56"/ 370 mm	10.62" x 9.84/ 270 x 250 mm	0-2.5 mm	178 lbs./ 80.7 kg	198 lbs./ 90 kg	37" x 33" x 38"/ 940 x 838 x 965 mm



Manual Volano Slicers With **Flower Flywheel** - 10"/12"/ 14"/ 14.5" Dia. Blades

- 10" Blade Size - Item 26072
- 12" Blade Size - Item 26073
- 14" Blade Size - Item 26074
- 14.5" Blade Size - Item 20387



ITEM	MODEL	BLADE SIZE	CUTTING SIZE	CUT THICKNESS	MACHINE WEIGHT	GROSS WEIGHT	GROSS DIMENSIONS
26072	MS-IT-0250-MF	10"/250 mm	7.3" x 5.9"/ 185.4 x 150 mm	0-2 mm	72.6 lbs./ 33 kg	124 lbs./ 56 kg	30" x 30" x 27"/ 762 x 762 x 686 mm
26073	MS-IT-0300-MF	12"/300 mm	9" x 7.5"/ 228.6 x 190.5 mm	0-2 mm	100 lbs./ 45 kg	169 lbs./ 76.7 kg	30" x 30" x 27"/ 762 x 762 x 686 mm
26074	MS-IT-0350-MF	14"/350 mm	10.62" x 9.44"/ 270 x 240 mm	0-2.5 mm	178 lbs./ 80.7 kg	198 lbs./ 90 kg	37" x 33" x 38"/ 940 x 838 x 965 mm
20387	MS-IT-0370-MF	14.56" /370 mm	10.62" x 9.84/ 270 x 250 mm	0-2.5 mm	178 lbs./ 80.7 kg	198 lbs./ 90 kg	37" x 33" x 38"/ 940 x 838 x 965 mm



Optional Item - Pedestal (Sold separately)



ITEM	DESCRIPTION	WEIGHT
20014	Pedestal for MS-IT-0250-M (Item 20013) / MS-IT-0250-MF (Item 26072)	169 lbs. / 76.7 kg
18986	Pedestal for MS-IT-0300-M (Item 13634) / MS-IT-0300-MF (Item 26073)	169 lbs. / 76.7 kg
18987	Pedestal for MS-IT-0350-M (Item 13639) / MS-IT-0370-M (Item 18830) / MS-IT-0350-MF (Item 26074) / MS-IT-0370-MF (Item 20387)	176 lbs./ 80 kg

OMCAN INC.

Telephone: 1-800-465-0234
 Fax: (905) 607-0234
 E-mail: sales@omcan.com
 Website: www.omcan.com



Follow us to keep up to date with the latest news and offers



MEAT SLICERS

VOLANO MANUAL SLICERS



Volano Manual Slicers **Technical Drawing With Dimensions**

Item 20013 / 26072

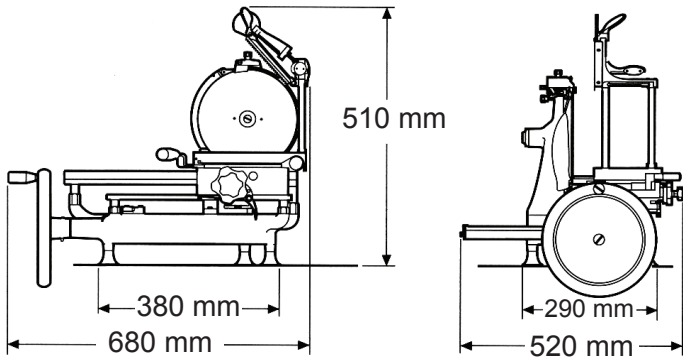

Item 13634 / 26073

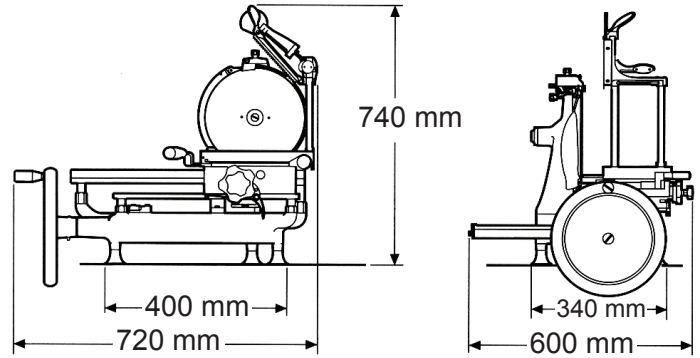

Item 13639 / 26074

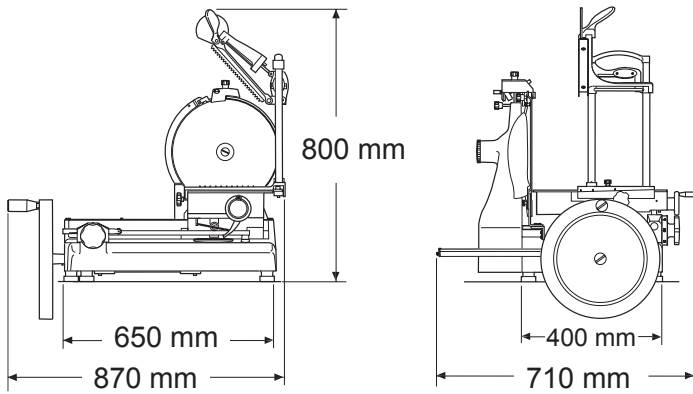

Item 18830 / 20387

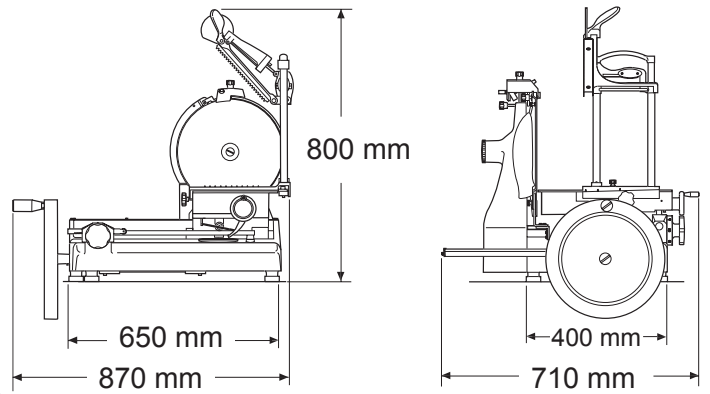

Pedestal **Technical Drawing With Dimensions**

Item 20014

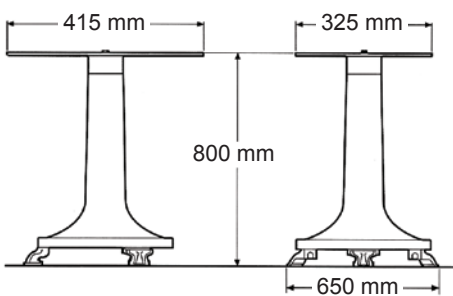

Item 18986

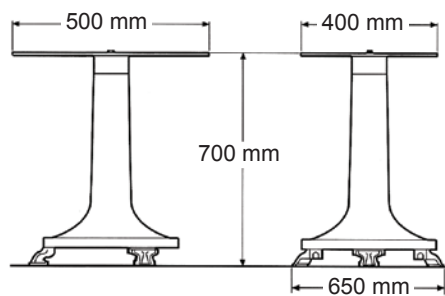

Item 18987

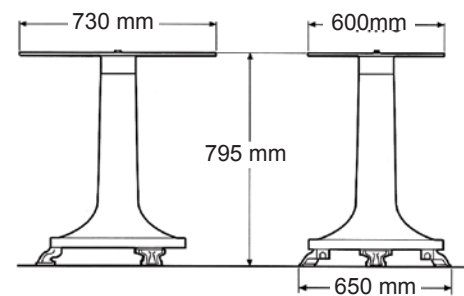

OMCAN INC.

Telephone: 1-800-465-0234

Fax: (905) 607-0234

E-mail: sales@omcan.com

Website: www.omcan.com



Follow us to keep up to date with the latest news and offers

