



- Undercounter dishwasher;
- Stainless steel construction 18/10 AISI 304;
- Wash cycle time: 2 minutes;
- Wash and rinse temperature thermometers;
- Stainless steel lower and upper rotating wash arms;
- Stainless steel lower rotating rinsing and upper fixed;
- Extractable control panel for an easy maintenance;
- Rinse aid dispenser;
- Detergent pump,
- Automatic tank loading;
- Door opening safety device;
- Thermocontrol: device which guarantees the selected temperature for every rinsing cycle even in case of non-stop work;
- Security thermostat;



• Certifications: UL, UL Sanitation;

SIZE:
23 3/4" W x 25" D x 32 1/2" H
Cycle period: 2 minutes

Capacity per hour:
Baskets/H 30

DSP4

Accessories:
1 basket for dishes;
1 generic basket;
1 cutlery container;

OPTIONS ,
• Stainless steel base H17,72 inch,

Specifications	DSP4	
VOLTAGE	208 V1ph 60Hz	V
WASHING PUMP	550	W
WASH TANK ELEMENTS	2000	W
RINSE TANK ELEMENTS	3000	W
TOTAL RATING	3550	W
MAX CURRENT INTENSITY	17/15	A
PLATES CLEARANCE	11,81	inch
WORK HEIGHT	12,40	inch
TANK CAPACITY	4	Gal.
BOILER CAPACITY	1,32	Gal.
PUMP DELIVERY	69	Gal./min
WATER CONNECTION	131	°F
WATER CONSUMPTION PER CYCLE	0,6	Gal.
WATER CONSUMPTION PER HOUR	19	Gal.
INLET WATER PRESSURE	40÷80	psi
WATER HARDNESS	7,2 ÷ 12,5	°f
RINSING WATER TEMPERATURE	180 ÷ 195	°F
WATER INLET	3/4"	"G
WATER OUTLET	3/4"	"G
NET WEIGHT	62	Kg
GROSS WEIGHT	70	Kg
PACKING SIZE	25,50Wx28,74Dx38,58H	inch
NOISE LEVEL	<70	dB(A)

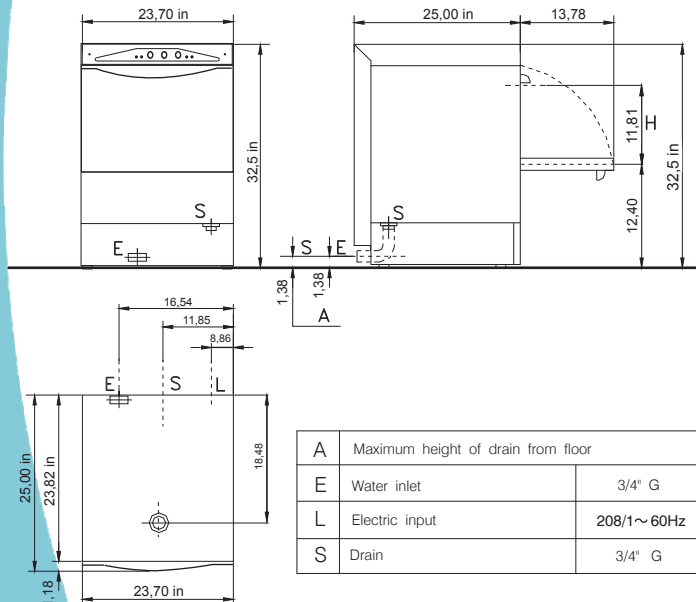
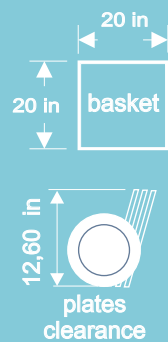

The manufacturer reserves the right to make modifications of materials and models without warning.